

# sturdi-built

GREENHOUSE MANUFACTURING CO.



## GREENHOUSE PRICE LIST

### 2024

Sturdi-Built Greenhouse Mfg. Co., 11304 SW Boones Ferry Rd., Portland, OR 97219

Sturdi-Built.com

## Sturdi-Built Greenhouse Features

- Framed with Clear All-Heart, Kiln Dried Redwood: The highest quality framing material available — warm, beautiful, durable and naturally resistant to deterioration.
- Custom greenhouse widths and lengths are available for all models except Trillium. Most of our models can be modified to fit unique situations, such as a pre-existing foundation or wall.
- All models can be paired with our redwood and cedar base wall with built-in vents. Or, build your own (dimensions provided).
- Glazing: Standard glass is our material of choice, however twin wall polycarbonate glazing or tempered glass are available. A popular combination is tempered glass in the roof with standard glass walls.
- Thermal Option™: Use our exclusive Thermal Option to create a more energy-efficient and insulated greenhouse. See page 8 for more information.
- Hassle-free Roof Venting: All of our models include non-electric Automatic Roof Vent Opener(s).
- Handmade Redwood Doors: The size and type of door varies with the greenhouse size and model. Doors can be hinged right or left and made to swing in or out. "Dutch" and double door options available.
- Add beautiful redwood benches or shelves for your plants and workspace needs. Prices listed for benches are for full-length along side wall(s).
- Jalousie Windows: Increase ventilation by adding jalousie windows. Attractively framed in redwood.
- Add our eave overhangs, finials, gussets or ridge scallop to add style to your greenhouse.
- Exclusive Prefabrication: Greenhouse end walls are factory pre-assembled and shipped.

## Receiving Your Greenhouse

**Local Delivery** - Pacific Northwest only. The greenhouse kit arrives as individual components. If you select Factory Prefabrication, the roof, end walls, and side walls will arrive as pre-assembled sections.

**Pick-up in Portland** - Call ahead and let us know the type of truck or trailer you will use. Bring straps and tarps (plan for the weather), we will help you load. Customers have flown to Portland for holiday and rented a truck to drive their greenhouse kit home with them. Your greenhouse will not be crated.

**Ship Common Carrier** - When we ship a greenhouse kit, we email you tracking information. The carrier will call to schedule a date/time window for delivery. Shipped greenhouse kits are crated for protection. Uncrating is easy.

**Door-to-Door, Nationwide** - The greenhouse kit is loaded at our dock and is driven directly to your location. This option avoids the risk of freight damage, and permits factory prefabrication of the roof and side walls.



Prefabricated sections for delivery or pickup



Crated for shipment

**Questions? Call us! (503) 244-4100 or (800) 334-4115 or email: [sturdi@sturdi-built.com](mailto:sturdi@sturdi-built.com)**

# Freestanding Styles

**Deluxe Regular** 10' and 12' widths have redwood beams. 14' & 16' widths come with pipe beams and center posts.

| Width               | Length | Greenhouse<br>without<br>Base Wall | 32" High                  |                    | Tempered              |                   | 2-Tier<br>Benches |
|---------------------|--------|------------------------------------|---------------------------|--------------------|-----------------------|-------------------|-------------------|
|                     |        |                                    | Sturdi-Built<br>Base Wall | Thermal<br>Option™ | Glass or<br>Twin Wall | 1-Tier<br>Benches |                   |
| <b>9' Regular</b>   | 12'    | <b>\$ 9,310</b>                    | \$ 1,800                  | \$ 2,390           | \$ 1,060              | \$ 1,320          | \$ 1,840          |
| <b>Freestanding</b> | 14'    | <b>10,660</b>                      | 2,110                     | 2,650              | 1,230                 | 1,600             | 2,280             |
| height: 8'-2"       | 16'    | <b>11,870</b>                      | 2,400                     | 2,920              | 1,410                 | 1,600             | 2,280             |
| 30" wide door       | 18'    | <b>13,080</b>                      | 2,560                     | 3,180              | 1,580                 | 1,680             | 2,400             |
| <b>10' Regular</b>  | 12'    | <b>11,690</b>                      | 1,900                     | 2,740              | 1,190                 | 1,320             | 1,840             |
| <b>Freestanding</b> | 14'    | <b>13,320</b>                      | 2,190                     | 3,010              | 1,390                 | 1,600             | 2,280             |
| height: 8'-7"       | 16'    | <b>14,890</b>                      | 2,480                     | 3,300              | 1,580                 | 1,600             | 2,280             |
| 35" wide door       | 18'    | <b>16,350</b>                      | 2,650                     | 3,590              | 1,780                 | 1,680             | 2,400             |
| <b>12' Regular</b>  | 14'    | <b>18,160</b>                      | 2,240                     | 3,600              | 1,670                 | 1,600             | 2,280             |
| <b>Freestanding</b> | 16'    | <b>20,580</b>                      | 2,650                     | 3,920              | 1,900                 | 1,600             | 2,280             |
| height: 9'-1"       | 18'    | <b>23,000</b>                      | 2,830                     | 4,240              | 2,150                 | 1,680             | 2,400             |
| 35" wide door       | 20'    | <b>26,030</b>                      | 3,000                     | 4,550              | 2,390                 | 1,760             | 2,560             |
| <b>14' Regular</b>  | 14'    | <b>17,310</b>                      | 2,410                     | 4,080              | 1,870                 | 1,600             | 2,280             |
| <b>Freestanding</b> | 16'    | <b>19,880</b>                      | 2,830                     | 4,420              | 2,130                 | 1,600             | 2,280             |
| height: 9'-8"       | 18'    | <b>21,910</b>                      | 3,000                     | 4,760              | 2,400                 | 1,680             | 2,400             |
| 36" wide door       | 20'    | <b>24,820</b>                      | 3,160                     | 5,120              | 2,660                 | 1,760             | 2,560             |
| <b>16' Regular</b>  | 18'    | <b>24,940</b>                      | 3,160                     | 5,500              | 2,830                 | 1,680             | 2,400             |
| <b>Freestanding</b> | 20'    | <b>28,340</b>                      | 3,590                     | 5,870              | 3,150                 | 1,760             | 2,560             |
| height: 10'-0"      | 21'    | <b>30,990</b>                      | 3,750                     | 6,270              | 3,300                 | 2,400             | 3,420             |
| 36" wide door       | 23'    | <b>31,600</b>                      | 3,890                     | 6,490              | 3,450                 | 2,400             | 3,420             |

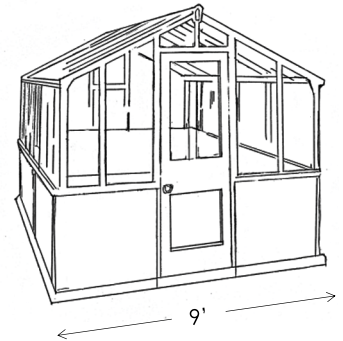

9' Deluxe Regular Freestanding

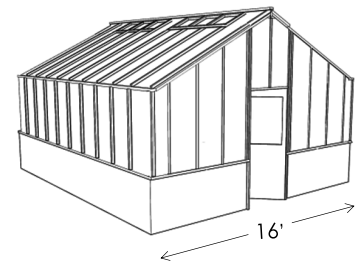

16' Deluxe Regular Freestanding

**Deluxe Glass-to-Ground** Designed to sit on a 9 1/2" high base wall. 10' model comes with redwood beams.

| Width                      | Length | Greenhouse<br>without<br>Base Wall | 9.5" High                 |                   | Tempered              |                   | 2-Tier<br>Benches |
|----------------------------|--------|------------------------------------|---------------------------|-------------------|-----------------------|-------------------|-------------------|
|                            |        |                                    | Sturdi-Built<br>Base Wall | Thermal<br>Option | Glass or<br>Twin Wall | 1-Tier<br>Benches |                   |
| <b>9' Glass-to-Ground</b>  | 12'    | <b>\$ 11,970</b>                   | \$ 1,120                  | \$ 3,110          | \$ 1,060              | \$ 1,320          | \$ 1,840          |
| <b>Freestanding</b>        | 14'    | <b>13,770</b>                      | 1,350                     | 3,450             | 1,230                 | 1,600             | 2,280             |
| height: 8'-4"              | 16'    | <b>15,490</b>                      | 1,590                     | 3,770             | 1,410                 | 1,600             | 2,280             |
| 30" wide door              | 18'    | <b>16,610</b>                      | 1,700                     | 4,100             | 1,580                 | 1,680             | 2,400             |
| <b>10' Glass-to-Ground</b> | 12'    | <b>13,530</b>                      | 1,190                     | 3,450             | 1,190                 | 1,320             | 1,840             |
| <b>Freestanding</b>        | 14'    | <b>15,620</b>                      | 1,410                     | 3,800             | 1,390                 | 1,600             | 2,280             |
| height: 8'-8"              | 16'    | <b>17,580</b>                      | 1,640                     | 4,140             | 1,580                 | 1,600             | 2,280             |
| 35" wide door              | 18'    | <b>19,320</b>                      | 1,750                     | 4,490             | 1,780                 | 1,680             | 2,400             |

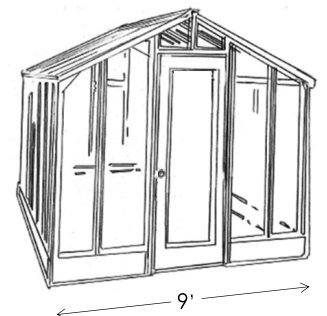

9' Deluxe Glass-to-Ground Freestanding

**Questions? Call us! (503) 244-4100 or (800) 334-4115 or email: [sturdi@sturdi-built.com](mailto:sturdi@sturdi-built.com)**



**Garden Deluxe** Includes arched door, one finial, eave overhangs, and rafter trusses or beams for roof support.

| Width               | Length | Greenhouse without Base Wall | 18" High Sturdi-Built Base Wall | Thermal Option™ | Tempered Glass or Twin Wall Roof | 1-Tier Benches | 2-Tier Benches |
|---------------------|--------|------------------------------|---------------------------------|-----------------|----------------------------------|----------------|----------------|
| <b>9'</b>           | 12'    | <b>\$ 13,870</b>             | \$ 1,620                        | \$ 3,110        | \$ 1,060                         | \$ 1,320       | \$ 1,840       |
| <b>Freestanding</b> | 14'    | <b>15,900</b>                | 1,890                           | 3,450           | 1,230                            | 1,600          | 2,280          |
| height: 9'-0"       | 16'    | <b>17,860</b>                | 2,160                           | 3,770           | 1,410                            | 1,600          | 2,280          |
| 30" wide door       | 18'    | <b>19,710</b>                | 2,320                           | 4,100           | 1,580                            | 1,680          | 2,400          |
| <b>10'</b>          | 12'    | <b>17,250</b>                | 1,700                           | 3,390           | 1,190                            | 1,320          | 1,840          |
| <b>Freestanding</b> | 14'    | <b>19,890</b>                | 1,980                           | 3,730           | 1,390                            | 1,600          | 2,280          |
| height: 9'-3"       | 16'    | <b>22,420</b>                | 2,240                           | 4,090           | 1,580                            | 1,600          | 2,280          |
| 35" wide door       | 18'    | <b>25,140</b>                | 2,400                           | 4,430           | 1,780                            | 1,680          | 2,400          |
| <b>12'</b>          | 14'    | <b>24,280</b>                | 2,120                           | 4,320           | 1,670                            | 1,600          | 2,280          |
| <b>Freestanding</b> | 16'    | <b>27,230</b>                | 2,400                           | 4,710           | 1,900                            | 1,600          | 2,280          |
| height: 9'-10"      | 18'    | <b>30,310</b>                | 2,550                           | 5,090           | 2,150                            | 1,680          | 2,400          |
| 35" wide door       | 20'    | <b>33,890</b>                | 2,710                           | 5,480           | 2,390                            | 1,760          | 2,560          |
| <b>14'</b>          | 14'    | <b>28,270</b>                | 2,280                           | 4,850           | 1,870                            | 1,600          | 2,280          |
| <b>Freestanding</b> | 16'    | <b>31,790</b>                | 2,550                           | 5,260           | 2,130                            | 1,600          | 2,280          |
| height: 10'-5"      | 18'    | <b>35,350</b>                | 2,710                           | 5,670           | 2,400                            | 1,680          | 2,400          |
| 36" wide door       | 20'    | <b>40,050</b>                | 2,850                           | 6,080           | 2,660                            | 1,760          | 2,560          |
| <b>16'</b>          | 18'    | <b>42,500</b>                | 2,850                           | 6,450           | 2,830                            | 1,680          | 2,400          |
| <b>Freestanding</b> | 20'    | <b>46,570</b>                | 3,160                           | 6,900           | 3,150                            | 1,760          | 2,560          |
| height: 10'-10"     | 21'    | <b>48,540</b>                | 3,330                           | 7,360           | 3,300                            | 2,400          | 3,420          |
| 36" wide door       | 23'    | <b>51,130</b>                | 3,640                           | 7,800           | 3,620                            | 2,400          | 3,420          |

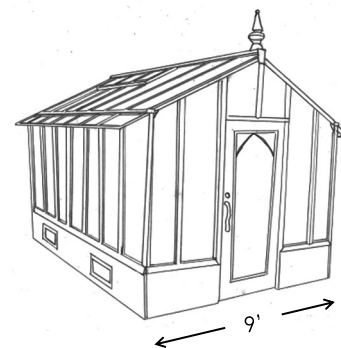

9' Garden Deluxe Freestanding

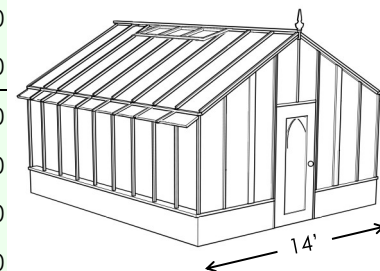

14' Garden Deluxe Freestanding

**Nantucket** Includes double arched doors, two jalousie windows, eave overhangs, gussets, ridge scallop and two finials.

| Width               | Length | Greenhouse without Base Wall | 18" High Sturdi-Built Base Wall | Thermal Option | Tempered Glass or Twin Wall Roof | 1-Tier Benches | 2-Tier Benches |
|---------------------|--------|------------------------------|---------------------------------|----------------|----------------------------------|----------------|----------------|
| <b>8'</b>           | 12'    | <b>\$ 19,220</b>             | \$ 1,530                        | \$ 2,880       | \$ 1,190                         | \$ 1,320       | \$ 1,840       |
| <b>Freestanding</b> | 14'    | <b>22,100</b>                | 1,810                           | 3,190          | 1,390                            | 1,460          | 1,720          |
| height: 9'-2"       | 16'    | <b>24,940</b>                | 2,100                           | 3,510          | 1,580                            | 1,460          | 1,720          |
| Dbl 30" wide doors  | 18'    | <b>27,780</b>                | 2,240                           | 3,820          | 1,780                            | 1,500          | 2,120          |
| <b>10'</b>          | 12'    | <b>24,570</b>                | 1,700                           | 3,420          | 1,620                            | 1,320          | 1,840          |
| <b>Freestanding</b> | 14'    | <b>28,220</b>                | 1,980                           | 3,770          | 1,880                            | 1,460          | 1,720          |
| height: 9'-6"       | 16'    | <b>30,950</b>                | 2,240                           | 4,110          | 2,150                            | 1,460          | 1,720          |
| Dbl 30" wide doors  | 18'    | <b>34,560</b>                | 2,400                           | 4,460          | 2,420                            | 1,500          | 2,120          |
| <b>12'</b>          | 12'    | <b>29,830</b>                | 1,850                           | 3,990          | 1,770                            | 1,320          | 1,840          |
| <b>Freestanding</b> | 14'    | <b>31,800</b>                | 2,120                           | 4,360          | 2,070                            | 1,460          | 1,720          |
| height: 9'-9"       | 16'    | <b>35,790</b>                | 2,400                           | 4,740          | 2,370                            | 1,460          | 1,720          |
| Dbl 30" wide doors  | 18'    | <b>39,620</b>                | 2,550                           | 5,120          | 2,650                            | 1,500          | 2,120          |

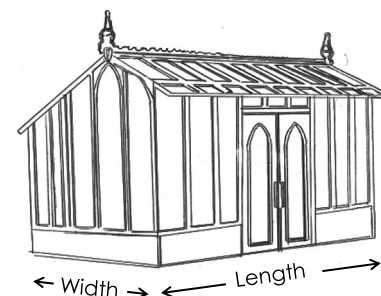

8' Nantucket Freestanding

Questions? Call us! (503) 244-4100 or (800) 334-4115 or email: [sturdi@sturdi-built.com](mailto:sturdi@sturdi-built.com)

## Freestanding Styles

**Solite** Consider placing the 8' wide Solite on an 18" high base wall.\*

| Width                   | Length | Greenhouse without Base Wall | 9.5" High Sturdi-Built Base Wall | Thermal Option™ | Tempered Glass or Twin Wall Roof | 1-Tier Benches | 2-Tier Benches |
|-------------------------|--------|------------------------------|----------------------------------|-----------------|----------------------------------|----------------|----------------|
| <b>8' Freestanding</b>  | 9'     | <b>\$ 6,340</b>              | \$ 920                           | \$ 2,120        | \$ 510                           | \$ 760         | \$ 1,020       |
| height: 7'-8"           | 11'    | <b>7,240</b>                 | 1,030                            | 2,390           | 620                              | 780            | 1,060          |
| 24" wide door           | 12'    | <b>7,790</b>                 | 1,080                            | 2,530           | 670                              | 1,200          | 1,560          |
|                         | 14'    | <b>8,970</b>                 | 1,310                            | 2,790           | 780                              | 1,440          | 1,920          |
| <b>11' Freestanding</b> | 14'    | <b>13,100</b>                | 1,470                            | 3,630           | 1,180                            | 1,600          | 2,280          |
| height: 8'-1"           | 16'    | <b>14,540</b>                | 1,700                            | 3,960           | 1,350                            | 1,600          | 2,280          |
| 36" wide door           | 18'    | <b>15,830</b>                | 1,800                            | 4,280           | 1,520                            | 1,680          | 2,400          |

\* 8' wide Freestanding has 6'-4" high door (2" shorter than standard door height). Using an optional 18" high base wall will allow for standard height door. Additional costs apply.

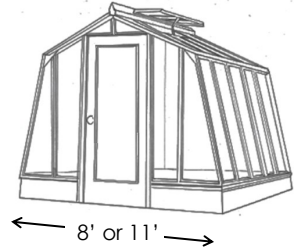

8' Solite Freestanding

**Tropic** Our 16' wide Tropic greenhouse can accommodate benches in center.

| Width                   | Length | Greenhouse without Base Wall | 32" High Sturdi-Built Base Wall | Thermal Option | Tempered Glass or Twin Wall Roof | 1-Tier Benches | 2-Tier Benches |
|-------------------------|--------|------------------------------|---------------------------------|----------------|----------------------------------|----------------|----------------|
| <b>10' Freestanding</b> | 12'    | <b>\$ 9,920</b>              | \$ 1,900                        | \$ 2,440       | \$ 1,010                         | \$ 1,320       | \$ 1,840       |
| height: 8'-0"           | 14'    | <b>11,240</b>                | 2,190                           | 2,700          | 1,180                            | 1,600          | 2,280          |
| 30" wide door           | 16'    | <b>12,450</b>                | 2,480                           | 2,960          | 1,350                            | 1,600          | 2,280          |
| <b>16' Freestanding</b> | 20'    | <b>27,240</b>                | 3,590                           | 5,630          | 2,970                            | 1,760          | 2,560          |
| height: 10'-0"          | 24'    | <b>30,690</b>                | 4,170                           | 6,370          | 3,560                            | 2,400          | 3,420          |
| 36" wide door           | 28'    | <b>32,630</b>                | 4,750                           | 7,120          | 4,160                            | 2,520          | 3,600          |

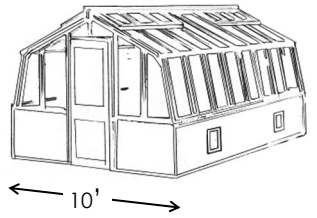

10' Tropic Freestanding

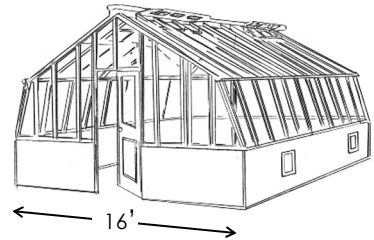

16' Tropic Freestanding

**Tudor** Includes arched door, arched above-door glazing and gussets.

| Width                   | Length | Greenhouse without Base Wall | 32" High Sturdi-Built Base Wall | Thermal Option | Tempered Glass or Twin Wall Roof | 1-Tier Benches | 2-Tier Benches |
|-------------------------|--------|------------------------------|---------------------------------|----------------|----------------------------------|----------------|----------------|
| <b>8' Freestanding</b>  | 9'     | <b>\$ 9,810</b>              | \$ 2,070                        | \$ 1,990       | \$ 890                           | \$ 760         | \$ 1,020       |
| height: 9'-3"           | 11'    | <b>11,890</b>                | 2,240                           | 2,240          | 1,090                            | 780            | 1,060          |
| 30" wide door           | 12'    | <b>12,740</b>                | 2,390                           | 2,370          | 1,190                            | 1,200          | 1,560          |
|                         | 14'    | <b>14,580</b>                | 2,560                           | 2,610          | 1,390                            | 1,440          | 1,920          |
| <b>10' Freestanding</b> | 12'    | <b>16,170</b>                | 2,510                           | 3,050          | 1,510                            | 1,320          | 1,840          |
| height: 10'-0"          | 14'    | <b>18,490</b>                | 2,680                           | 3,340          | 1,760                            | 1,600          | 2,280          |
| 35" wide door           | 16'    | <b>20,820</b>                | 2,910                           | 3,630          | 2,000                            | 1,600          | 2,280          |
| <b>12' Freestanding</b> | 12'    | <b>19,970</b>                | 3,150                           | 3,760          | 1,830                            | 1,300          | 2,020          |
| height: 11'-0"          | 14'    | <b>22,790</b>                | 3,330                           | 4,100          | 2,120                            | 1,400          | 2,320          |
| 35" wide door           | 16'    | <b>25,720</b>                | 3,740                           | 4,440          | 2,430                            | 1,400          | 2,320          |
|                         | 18'    | <b>28,290</b>                | 3,920                           | 4,800          | 2,730                            | 1,570          | 2,450          |
| <b>14' Freestanding</b> | 14'    | <b>27,190</b>                | 3,190                           | 5,040          | 2,510                            | 1,600          | 2,280          |
| height: 12'-0"          | 16'    | <b>30,370</b>                | 3,370                           | 5,430          | 2,860                            | 1,600          | 2,280          |
| 35" wide door           | 18'    | <b>33,560</b>                | 3,610                           | 5,830          | 3,220                            | 1,680          | 2,400          |
|                         | 20'    | <b>37,970</b>                | 3,770                           | 6,230          | 3,580                            | 1,760          | 2,560          |

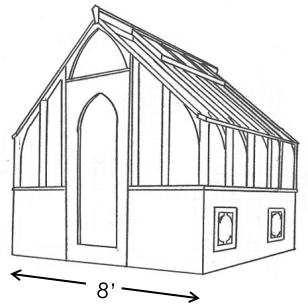

8' Tudor Freestanding

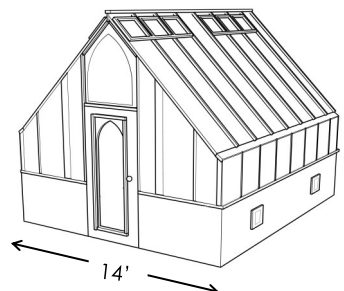

14' Tudor Freestanding

**Questions? Call us! (503) 244-4100 or (800) 334-4115 or email: [sturdi@sturdi-built.com](mailto:sturdi@sturdi-built.com)**

## Trillium

- Made with a special laminated all-heart redwood frame, energy efficient twin wall polycarbonate roof and standard glass walls
- Includes 18" high, Redwood and Cedar base wall with built-in vents and 24" wide door
- Ample height (8'-4" at peak) with lots of vertical space for hanging plants and shelves
- Thermal Option™ (double glazing) available for extra energy efficiency

| Size  | Greenhouse with Sturdi-Built Base Wall | Thermal Option | Basic Package | or | Deluxe Package |
|---|--|----------------|---------------|----|----------------|
| 7' x 7'   | \$ 6,580                               | \$ 1,760       | \$ 970        |    | \$ 1,600       |
| 7' x 9'   | 8,260                                  | 2,040          | 1,140         |    | 1,780          |
| 7' x 11'  | 9,970                                  | 2,300          | 1,230         |    | 1,920          |
| Accessory Packages                                |  |                |               |    |                |
|   | Basic Package                          | Deluxe Package |               |    |                |
| (2) One-tier Benches                              | ✓                                      |                |               |    |                |
| (2) Two-tier Benches                              |  | ✓              |               |    |                |
| (2) Side Wall Shelves                             |  | ✓              |               |    |                |
| 120V Bio Green Palma Heater w/ Digital Thermostat | ✓                                      | ✓              |               |    |                |
| 12" Oscillating Wall Mount Fan                    | ✓                                      | ✓              |               |    |                |
| Thermometer/Hygrometer                            | ✓                                      |                |               |    |                |
| Wireless Thermometer/Hygrometer w/ Remote Sensor  |  | ✓              |               |    |                |
| Plant Hanging Bar                                 |  | ✓              |               |    |                |

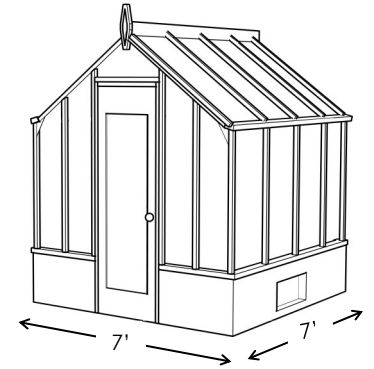

7' x 7' Trillium Freestanding

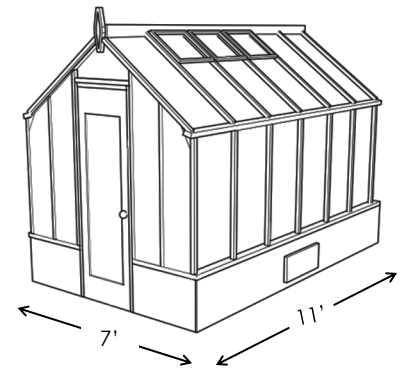

7' x 11' Trillium Freestanding



Bio Green Palma Heater



Oscillating Fan



Wireless Thermometer/Hygrometer with Remote Sensor



Benches

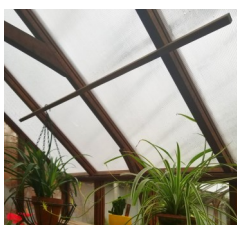

Plant Hanging Bar



Thermometer/Hygrometer

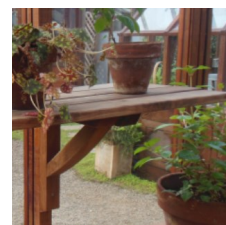

Side Wall Shelf

Questions? Call us! (503) 244-4100 or (800) 334-4115 or email: [sturdi@sturdi-built.com](mailto:sturdi@sturdi-built.com)

# Lean-to Styles

## Deluxe Regular Lean-to Regular is designed to sit on a 32" high base wall.

| Width                     | Length | Greenhouse without Base Wall | 32" High Sturdi-Built Base Wall | Thermal Option™ | Tempered Glass or Twin Wall Roof | 1-Tier Benches | 2-Tier Benches |
|---------------------------|--------|------------------------------|---------------------------------|-----------------|----------------------------------|----------------|----------------|
| <b>6' Regular Lean-to</b> | 12'    | <b>\$ 6,610</b>              | \$ 1,380                        | \$ 1,470        | \$ 690                           | \$ 660         | \$ 920         |
| height: 8'-1"             | 14'    | <b>7,500</b>                 | 1,560                           | 1,640           | 800                              | 800            | 1,140          |
| 30" wide door             | 16'    | <b>8,360</b>                 | 1,740                           | 1,780           | 910                              | 800            | 1,140          |
| <b>8' Regular Lean-to</b> | 12'    | <b>8,470</b>                 | 1,620                           | 1,960           | 910                              | 660            | 920            |
| height: 8'-9"             | 14'    | <b>9,680</b>                 | 1,790                           | 2,160           | 1,070                            | 800            | 1,140          |
| 30" wide door             | 16'    | <b>10,780</b>                | 1,980                           | 2,340           | 1,210                            | 800            | 1,140          |
| 30" wide door             | 18'    | <b>11,990</b>                | 2,080                           | 2,540           | 1,360                            | 840            | 1,200          |

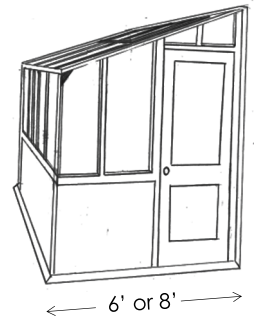

6' Deluxe Regular Lean-to

## Deluxe Glass-to-Ground Lean-to Designed to sit on a 9 1/2" high base wall.

| Width                     | Length | Greenhouse without Base Wall | 9.5" High Sturdi-Built Base Wall | Thermal Option | Tempered Glass or Twin Wall Roof | 1-Tier Benches | 2-Tier Benches |
|---------------------------|--------|------------------------------|----------------------------------|----------------|----------------------------------|----------------|----------------|
| <b>6' Glass to Ground</b> | 12'    | <b>\$ 8,420</b>              | \$ 460                           | \$ 1,980       | \$ 690                           | \$ 660         | \$ 920         |
| height: 8'-2"             | 14'    | <b>9,780</b>                 | 560                              | 2,190          | 800                              | 800            | 1,140          |
| 30" wide door             | 16'    | <b>11,070</b>                | 670                              | 2,390          | 910                              | 800            | 1,140          |
| <b>8' Glass to Ground</b> | 12'    | <b>10,620</b>                | 540                              | 2,430          | 910                              | 660            | 920            |
| height: 8'-10"            | 14'    | <b>11,610</b>                | 640                              | 2,650          | 1,070                            | 800            | 1,140          |
| 30" wide door             | 16'    | <b>12,300</b>                | 730                              | 2,870          | 1,210                            | 800            | 1,140          |

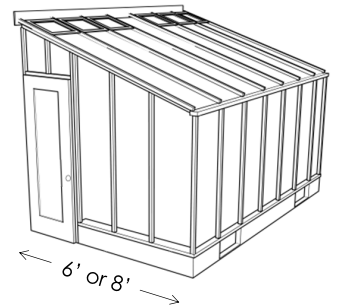

8' Deluxe Glass-to-Ground Lean-to

## Garden Sunroom Includes 2x6 redwood beam for support. 10' model has two beams.

| Width              | Length | Greenhouse without Base Wall | 18" High Sturdi-Built Base Wall | Thermal Option | Tempered Glass or Twin Wall Roof | 1-Tier Benches | 2-Tier Benches |
|--------------------|--------|------------------------------|---------------------------------|----------------|----------------------------------|----------------|----------------|
| <b>7' Lean-to</b>  | 12'    | <b>\$ 10,900</b>             | \$ 1,130                        | \$ 1,960       | \$ 800                           | \$ 660         | \$ 920         |
| height: 8'-6"      | 14'    | <b>11,200</b>                | 1,290                           | 2,150          | 940                              | 800            | 1,140          |
| 30" wide door      | 16'    | <b>12,100</b>                | 1,430                           | 2,330          | 1,070                            | 800            | 1,140          |
| <b>8' Lean-to</b>  | 12'    | <b>12,400</b>                | 1,220                           | 2,220          | 910                              | 660            | 920            |
| height: 8'-7"      | 14'    | <b>13,200</b>                | 1,370                           | 2,420          | 1,070                            | 800            | 1,140          |
| 30" wide door      | 16'    | <b>14,500</b>                | 1,510                           | 2,630          | 1,210                            | 800            | 1,140          |
|                    | 18'    | <b>15,900</b>                | 1,610                           | 2,840          | 1,360                            | 840            | 1,200          |
| <b>9' Lean-to</b>  | 12'    | <b>14,360</b>                | 1,310                           | 2,510          | 1,030                            | 660            | 920            |
| height: 9'-0"      | 14'    | <b>15,400</b>                | 1,450                           | 2,740          | 1,200                            | 800            | 1,140          |
| 36" wide door      | 16'    | <b>16,800</b>                | 1,610                           | 2,970          | 1,380                            | 800            | 1,140          |
|                    | 18'    | <b>18,100</b>                | 1,700                           | 3,190          | 1,550                            | 840            | 1,200          |
| <b>10' Lean-to</b> | 12'    | <b>16,100</b>                | 1,390                           | 3,040          | 1,140                            | 660            | 920            |
| height: 9'-4"      | 14'    | <b>17,300</b>                | 1,540                           | 3,280          | 1,340                            | 800            | 1,140          |
| 36" wide door      | 16'    | <b>19,100</b>                | 1,700                           | 3,520          | 1,530                            | 800            | 1,140          |
|                    | 18'    | <b>20,300</b>                | 1,780                           | 3,770          | 1,720                            | 840            | 1,200          |

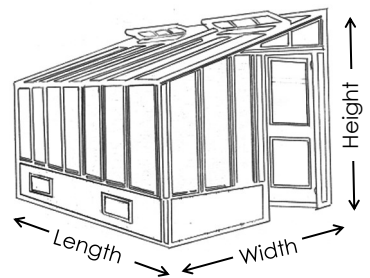

8' Garden Sunroom Lean-to

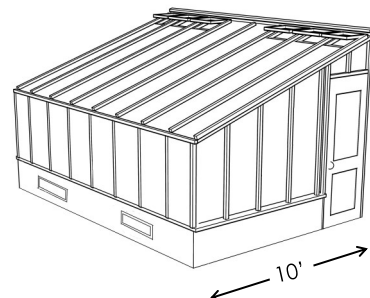

10' Garden Sunroom Lean-to

Questions? Call us! (503) 244-4100 or (800) 334-4115 or email: [sturdi@sturdi-built.com](mailto:sturdi@sturdi-built.com)



## Lean-to Styles

### Solite Lean-to

5 1/2' wide model has 6'-4" high door (2" shorter than standard). Consider placing it on an 18" high base wall to allow for standard 6'-6" door. Additional base wall costs apply.

| Width                 | Length | Greenhouse without Base Wall | 9.5" High Base Wall | Thermal Option™ | Tempered Glass or Twin Wall | 1-Tier Benches | 2-Tier Benches |
|-----------------------|--------|------------------------------|---------------------|-----------------|-----------------------------|----------------|----------------|
| <b>5 1/2' Lean-to</b> | 9'     | <b>\$ 5,640</b>              | \$ 390              | \$ 1,410        | \$ 390                      | \$ 380         | \$ 510         |
| height: 8'-2"         | 11'    | <b>6,350</b>                 | 420                 | 1,560           | 460                         | 390            | 530            |
| 24" wide door         | 12'    | <b>6,600</b>                 | 440                 | 1,650           | 510                         | 600            | 780            |
| <b>7 1/2' Lean-to</b> | 12'    | <b>9,020</b>                 | 520                 | 2,090           | 700                         | 660            | 920            |
| height: 8'-2"         | 14'    | <b>10,320</b>                | 680                 | 2,290           | 830                         | 800            | 1,140          |
| 30" wide door         | 16'    | <b>11,420</b>                | 830                 | 2,480           | 950                         | 800            | 1,140          |
| <b>9 1/2' Lean-to</b> | 12'    | <b>11,420</b>                | 590                 | 2,650           | 950                         | 660            | 920            |
| height: 9'-0"         | 14'    | <b>13,010</b>                | 750                 | 2,880           | 1,100                       | 800            | 1,140          |
| 30" wide door         | 16'    | <b>14,600</b>                | 920                 | 3,110           | 1,250                       | 800            | 1,140          |
|                       | 18'    | <b>15,950</b>                | 950                 | 3,340           | 1,420                       | 840            | 1,200          |



← 5 1/2', 7 1/2' or 9 1/2' →

7 1/2' Solite Lean-to

### Tropic Lean-to

Includes Standard door and pipe beam with wall braces for support.

| Width             | Length | Greenhouse without Base Wall | 32" High Sturdi-Built Base Wall | Thermal Option | Tempered Glass or Twin Wall Roof | 1-Tier Benches | 2-Tier Benches |
|-------------------|--------|------------------------------|---------------------------------|----------------|----------------------------------|----------------|----------------|
| <b>7' Lean-to</b> | 12'    | <b>\$ 7,510</b>              | \$ 1,500                        | \$ 1,580       | \$ 700                           | \$ 660         | \$ 920         |
| height: 8'-2"     | 14'    | <b>8,580</b>                 | 1,680                           | 1,750          | 830                              | 800            | 1,140          |
| 30" wide door     | 16'    | <b>9,550</b>                 | 1,850                           | 1,910          | 950                              | 800            | 1,140          |
|                   | 18'    | <b>10,520</b>                | 1,980                           | 2,070          | 1,060                            | 840            | 1,200          |
| <b>9' Lean-to</b> | 12'    | <b>9,910</b>                 | 1,730                           | 2,090          | 950                              | 660            | 920            |
| height: 8'-10"    | 14'    | <b>11,360</b>                | 1,910                           | 2,290          | 1,100                            | 800            | 1,140          |
| 30" wide door     | 16'    | <b>12,800</b>                | 2,080                           | 2,490          | 1,250                            | 800            | 1,140          |
|                   | 18'    | <b>14,140</b>                | 2,200                           | 2,680          | 1,420                            | 840            | 1,200          |

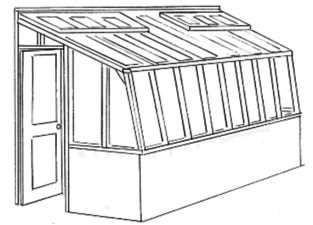

← 7' or 9' →

7' Tropic Lean-to

### Tudor Lean-to

Includes arched door, gussets, and redwood beam, and a steeper roof pitch.

| Width             | Length | Greenhouse without Base Wall | 32" High Sturdi-Built Base Wall | Thermal Option | Tempered Glass or Twin Wall | 1-Tier Benches | 2-Tier Benches |
|-------------------|--------|------------------------------|---------------------------------|----------------|-----------------------------|----------------|----------------|
| <b>7' Lean-to</b> | 11'    | <b>\$ 9,190</b>              | \$ 1,590                        | \$ 1,580       | \$ 690                      | \$ 440         | \$ 640         |
| height: 9'-0"     | 12'    | <b>10,810</b>                | 1,710                           | 1,760          | 840                         | 660            | 920            |
| 30" wide door     | 14'    | <b>12,380</b>                | 1,810                           | 1,940          | 980                         | 800            | 1,140          |
|                   | 16'    | <b>13,900</b>                | 1,910                           | 2,110          | 1,110                       | 800            | 1,140          |

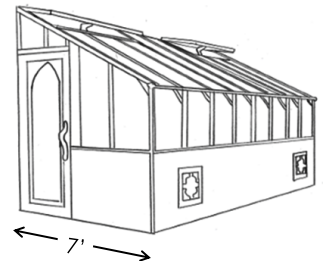

7' Tudor Lean-to

### Thermal Option™

- A double glazing system exclusive to Sturdi-Built Greenhouse - create a more energy-efficient and insulated greenhouse.
- Choice of materials: window-clear acrylic or white twin wall polyethylene. The white twin wall provides some shading and light diffusion.
- The Thermal Option can be added to all or any part of the greenhouse, either now or later.
- Designed to breathe to accommodate the high humidity levels and moisture condensation always present in greenhouses. Installation is easy.

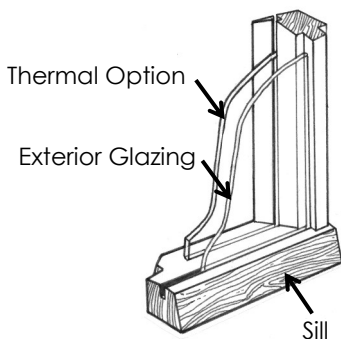

**Questions? Call us! (503) 244-4100 or (800) 334-4115 or email: [sturdi@sturdi-built.com](mailto:sturdi@sturdi-built.com)**